

SynQor®

MCOTS-C-270-12-HP

**Single Output
Half-brick**

MILITARY COTS DC-DC CONVERTER

230-425V Continuous Input	230-475V Transient Input	12V Output	42A Output	95% @ 21A / 95% @ 42A Efficiency
-------------------------------------	------------------------------------	----------------------	----------------------	--

Operation: -55°C to +100°C

The MilQor® series of Mil-COTS DC-DC converters brings SynQor's field proven high-efficiency synchronous rectification technology to the Military/Aerospace industry. SynQor's ruggedized encased packaging approach ensures survivability in demanding environments. Compatible with the industry standard format, these converters operate at a fixed frequency, and follow conservative component derating guidelines. They are designed and manufactured to comply with a wide range of military standards.

MilCOTS™



Designed and Manufactured in the USA

Safety Features

- 4250VDC, 100 MΩ input-to-output isolation - PENDING (see Technical Specifications pages)

Mechanical Features

- Industry standard half-brick pin-out configuration
- Size: 2.486" x 2.386" x 0.495" (63.14 x 60.60 x 12.57 mm)
- Total weight: 5.0 oz. (142 g)
- Flanged baseplate version available

Protection Features

- Input under-voltage lockout/over-voltage shutdown
- Output current limit and short circuit protection
- Active back bias limit
- Output over-voltage protection
- Thermal shutdown

Specification Compliance

MCOTS series converters (with an MCOTS filter) are designed to meet:

- MIL-HDBK-704 (A-F)
- MIL-STD-461 (C, D, E, F)

Operational Features

- High efficiency, 95% at full rated load current
- Operating input voltage range: 230-425 V
- Fixed frequency switching provides predictable EMI
- No minimum load requirement

Control Features

- On/Off control referenced to input return
- Remote sense for the output voltage
- Output voltage trim range of +10%, -20%
- Active current sharing (full feature option)
- Clock synchronization (full feature option)
- Start synchronization (full feature option)

Screening/Qualification

- AS9100 and ISO 9001 certified facility
- Qualified to MIL-STD-810
- Available with S-Grade or M-Grade screening
- Pre-cap inspection per IPC-A-610, Class III
- Temperature cycling per MIL-STD-883, Method 1010, Condition B, 10 cycles
- Burn-In at 100 °C baseplate temperature
- Final visual inspection per MIL-STD-883, Method 2009
- Full component traceability



MCOTS-C-270-12-HP

Output: 12V

Current: 42A

Technical Specification

MCOTS-C-270-12-HP ELECTRICAL CHARACTERISTICS

Tb = 25 °C, Vin = 270dc unless otherwise noted; full operating temperature range is -55 °C to +100 °C baseplate temperature with appropriate power derating. Specifications subject to change without notice.

Parameter	Min.	Typ.	Max.	Units	Notes & Conditions
ABSOLUTE MAXIMUM RATINGS					
Input Voltage					
Non-Operating	-1		600	V	Continuous
Operating			425	V	Continuous
Operating Transient Protection			475	V	1 s transient, square wave
Isolation Voltage					
Input to Output			4250	V dc	
Input to Base-Plate			2300	V dc	
Output to Base-Plate			2300	V dc	
Operating Temperature	-55		+100	°C	Baseplate temperature
Storage Temperature	-65		+135	°C	
Voltage at ON/OFF input pin	-2		18	V	
INPUT CHARACTERISTICS					
Operating Input Voltage Range	230	270	425	V	475V transient for 1 s
Input Under-Voltage Turn-On Threshold	203	215	227	V	
Input Under-Voltage Turn-Off Threshold	184	195	206	V	
Input Over-Voltage Turn-Off Threshold	430	455	480	V	
Input Over-Voltage Turn-On Threshold	420	445	470	V	
Recommended External Input Capacitance		4.7		µF	Typical ESR 1Ω see Note1
Input Filter Component Values (L/C)		10/0.63		µH/µF	Internal values; see Figure E
Maximum Input Current			3.0	A	Vin min; trim up; in current limit
No-Load Input Current		30	45	mA	
Disabled Input Current		3	7	mA	
Response to Input Transient		300		mV	Peak, see Figure 12
Input Terminal Ripple Current		25		mA	RMS, full load, 20MHz bandwidth
Recommended Input Fuse			5	A	Fast acting external fuse recommended
OUTPUT CHARACTERISTICS					
Output Voltage Set Point	11.88	12.00	12.12	V	
Output Voltage Regulation					
Over Line		±0.1	±0.3	%	
Over Load		±0.1	±0.3	%	
Over Temperature	-100		100	mV	
Total Output Voltage Range	11.70		12.30	V	Over sample, line, load, temperature & life
Output Voltage Ripple and Noise					20 MHz bandwidth; see Note 2
Peak-to-Peak		200	300	mV	Full load
RMS		70	105	mV	Full load
Operating Output Current Range			42	A	Subject to thermal derating
Output DC Current-Limit Inception	45	48	51	A	Output voltage 10% Low
Output DC Current-Limit Shutdown Voltage		12		V	
Back-Drive Current Limit while Enabled		20		A	Negative current drawn from output
Back-Drive Current Limit while Disabled		5		mA	Negative current drawn from output
Maximum Output Capacitance			8000	µF	Vout nominal at full load (resistive load)
Output Voltage during Load Current Transient					
Step Change in Output Current (0.1 A/µs)		300		mV	50% to 75% to 50% Iout max
Settling Time		150		µs	To within 1% Vout nom
Output Voltage Trim Range	-20		10	%	Across Pins 8&4; Figure C; see Note 3
Output Voltage Remote Sense Range			10	%	Across Pins 8&4
Output Over-Voltage Protection	13.6	14.5	15.4	V	Over full temp range
EFFICIENCY					
100% Load		95.0		%	See Figure 1 for efficiency curve
50% Load		94.5		%	See Figure 1 for efficiency curve

Note 1: An input capacitor with series resistance is necessary to provide system stability.

Note 2: Output is terminated with 1 µF ceramic and 15 µF low-ESR tantalum capacitors. For applications requiring reduced output voltage ripple and noise, consult SynQor applications support (e-mail: mqnbfae@synqor.com)

Note 3: Trim-up range is limited below 10% at low line and full load. Applying 6.2V between trim pin and Vout(-) may damage the unit.



MCOTS-C-270-12-HP

Output: 12V

Current: 42A

Technical Specification

MCOTS-C-270-12-HP ELECTRICAL CHARACTERISTICS

Tb = 25 °C, Vin = 270dc unless otherwise noted; full operating temperature range is -55 °C to +100 °C baseplate temperature with appropriate power derating. Specifications subject to change without notice.

Parameter	Min.	Typ.	Max.	Units	Notes & Conditions
DYNAMIC CHARACTERISTICS					
Turn-On Transient					
Turn-On Time		70		ms	Full load, Vout=90% nom.
Start-Up Inhibit Time	250	300	350	ms	See Figure F
Output Voltage Overshoot		0		%	Maximum Output Capacitance
ISOLATION CHARACTERISTICS					
Isolation Voltage (dielectric strength)			4250	V dc	See Absolute Maximum Ratings
Isolation Resistance		100		MΩ	
Isolation Capacitance (input to output)		N/A		pF	See Note 4
TEMPERATURE LIMITS FOR POWER DERATING CURVES					
Semiconductor Junction Temperature			125	°C	Package rated to 150 °C
Board Temperature			125	°C	UL rated max operating temp 130 °C
Transformer Temperature			125	°C	
Maximum Baseplate Temperature, Tb			100	°C	
FEATURE CHARACTERISTICS					
Switching Frequency	370	400	430	kHz	
ON/OFF Control					
Off-State Voltage	2.4		18	V	
On-State Voltage	-1		0.8		
ON/OFF Control					Application notes Figures A & B
Pull-Up Voltage		5		V	
Pull-Up Resistance		82.5		kΩ	
Over-Temperature Shutdown OTP Trip Point		125		°C	Average PCB Temperature
Over-Temperature Shutdown Restart Hysteresis		10		°C	
FULL FEATURE OPTION					
Clock Sync	370	400	450	kHz	See Note 5
Current Share		1.6		V	Half load
RELIABILITY CHARACTERISTICS					
Calculated MTBF per MIL-HDBK-217F		4.1		MHrs.	Ground Benign, 70°C Tb
Calculated MTBF per MIL-HDBK-217F		971		kHrs.	Ground Mobile, 70°C Tb

Note 4: Higher values of isolation capacitance can be added external to the module.

Note 5: Runs at switching freq if Clock signal is beyond the limit . The duty cycle of CLK sync should be between 30%-70%

STANDARDS COMPLIANCE

Parameter	Notes & Conditions
STANDARDS COMPLIANCE	
	Pending
UL 62368-1	Basic Insulation
CAN/CSA C22.2 No.62368-1	
EN 62368	

Note: An external input fuse must always be used to meet these safety requirements. Contact SynQor for official safety certificates on new releases or



MCOTS-C-270-12-HP

Output: 12V

Current: 42A

Technical Charts

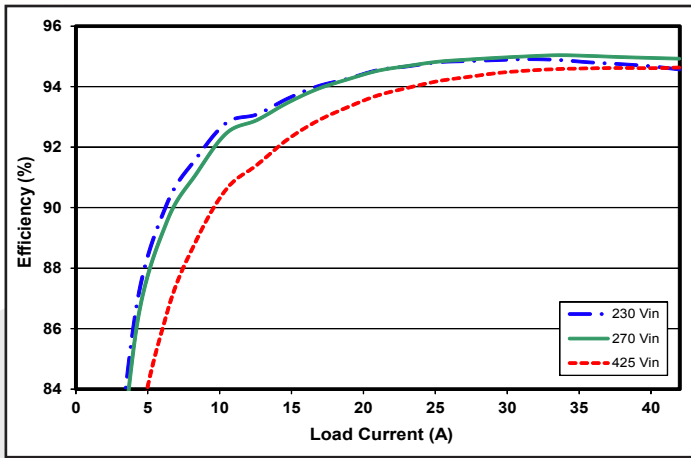

Figure 1: Efficiency at nominal output voltage vs. load current for minimum, nominal, and maximum input voltage at 25°C.

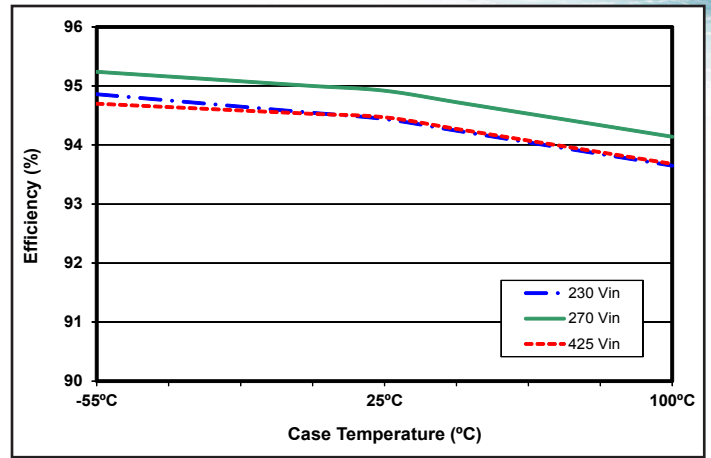

Figure 2: Efficiency at nominal output voltage and 100% rated power vs. case temperature for minimum, nominal, and maximum input voltage.

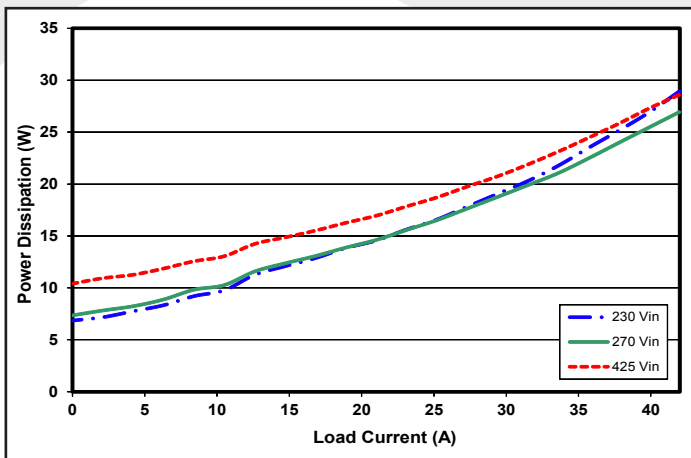

Figure 3: Power dissipation at nominal output voltage vs. load current for minimum, nominal, and maximum input voltage at $T_{CASE}=25^{\circ}C$.

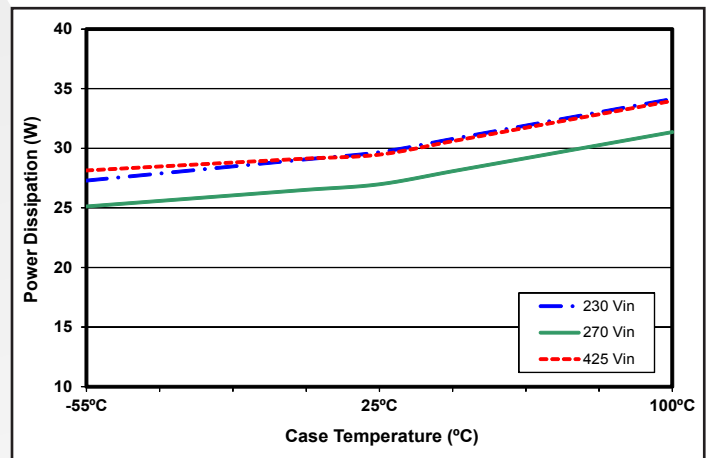

Figure 4: Power dissipation at nominal output voltage and 100% rated power vs. case temperature for minimum, nominal, and maximum input voltage.

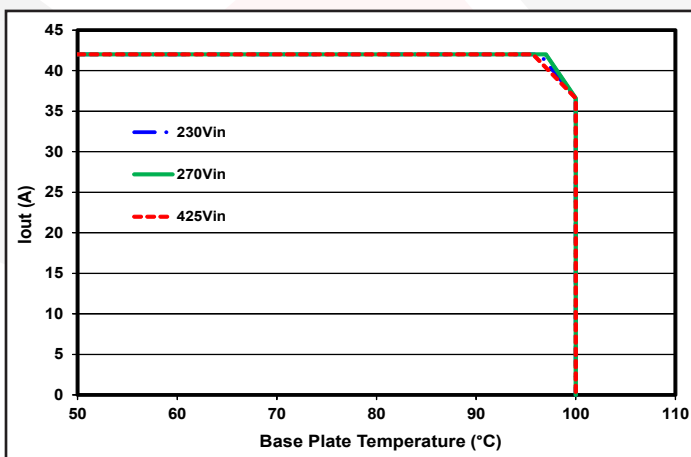

Figure 5: Maximum output current vs. base plate temperature.

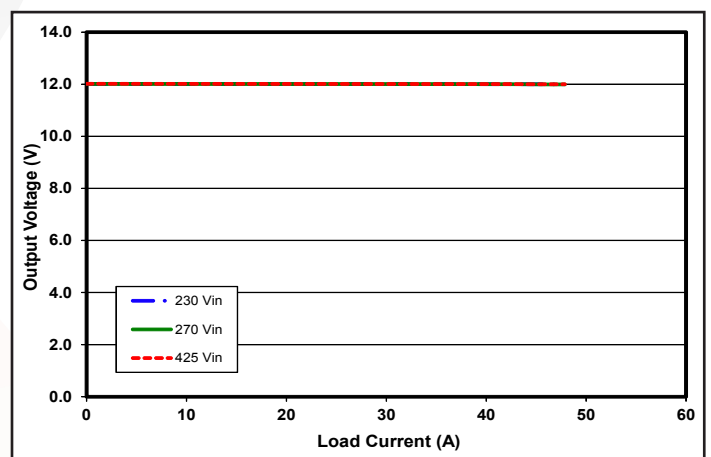

Figure 6: Output voltage vs. load current showing typical current limit curves. See Current Limit section in the Application Notes.



MCOTS-C-270-12-HP

Output: 12V

Current: 42A

Technical Charts

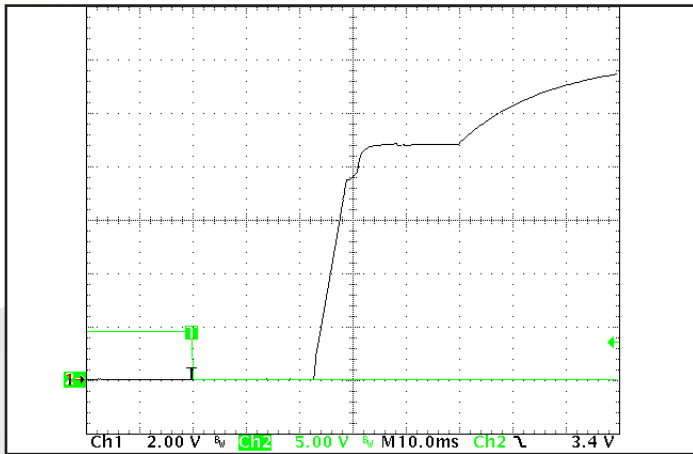

Figure 7: Typical startup waveform. Input voltage pre-applied, ON/OFF Pin on Ch 2, (10ms/div).

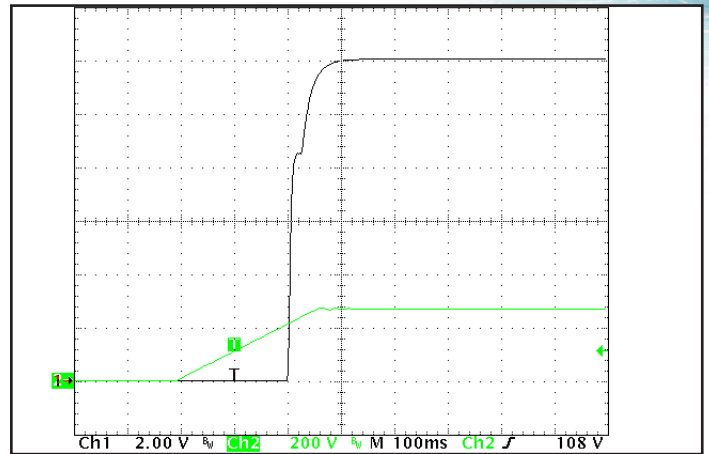

Figure 8: Turn-on transient at full resistive load and zero output capacitance initiated by Vin. ON/OFF Pin previously low. Ch 1: Vin (200V/div). Ch 3: Vout (2V/div), (100ms/div).

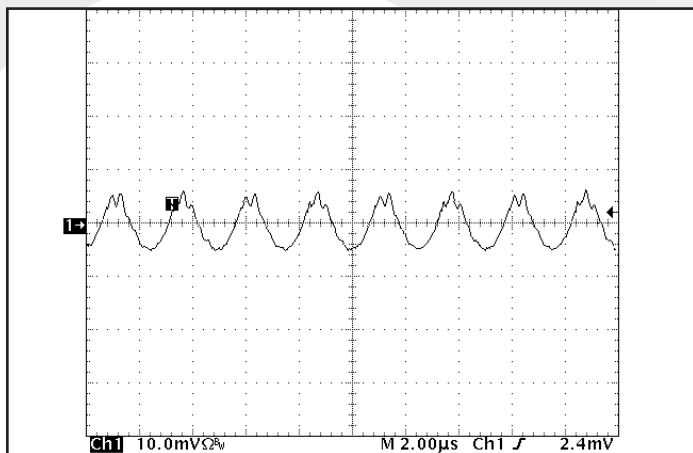

Figure 9: Input terminal current ripple, i_C , at full rated output current and nominal input voltage with 10µH source impedance and 10µF electrolytic capacitor (200mA/div), (2µs/div). Bandwidth: 20MHz. See Figure 17.

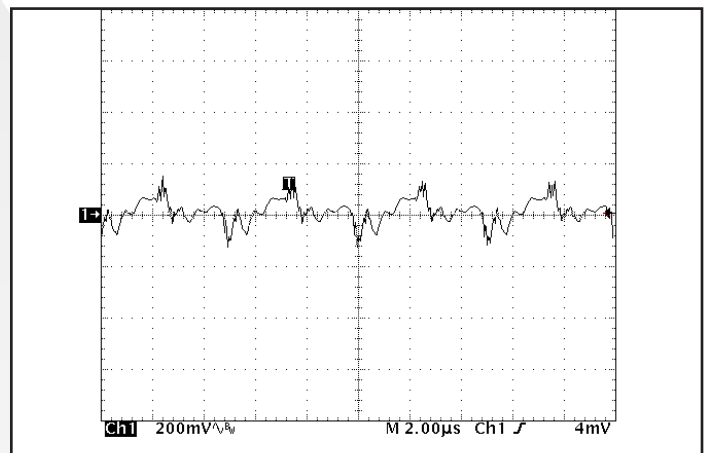

Figure 10: Output voltage ripple, V_{out} , at nominal input voltage and rated load current (200 mV/div), (2µs/div). Load capacitance: 1µF ceramic capacitor and 15µF tantalum capacitor. Bandwidth: 10 MHz. See Figure 17.

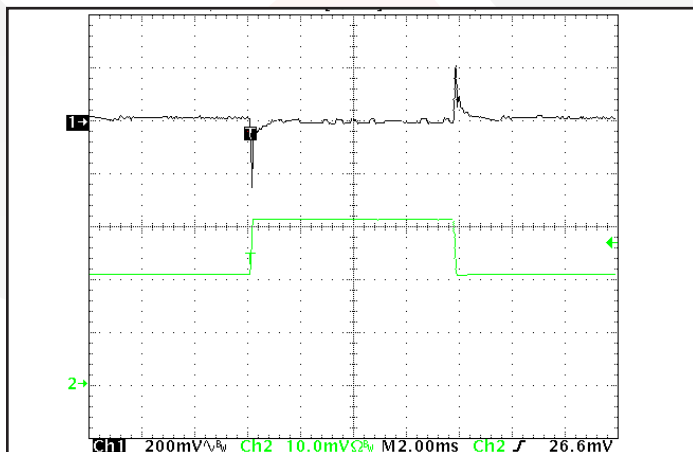

Figure 11: Output voltage response to step-change in load current (50%-75%-50% of $I_{out(max)}$); ($dI/dt = 0.1 A/\mu s$). Load cap: 1 µF ceramic and 15 µF tantalum capacitors. Ch 1: V_{out} (200mV/div), Ch 2: I_{out} (10A/div), (2ms/div).

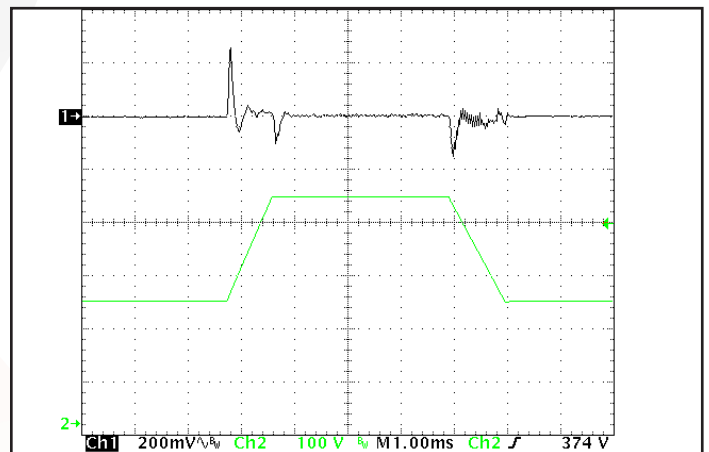

Figure 12: Output voltage response to step-change in input voltage (250V/ms). Load cap: 1µF ceramic and 15µF tantalum capacitors. Ch 1: V_{out} (200mV/div), Ch 2: V_{in} (100V/div), (1ms/div).

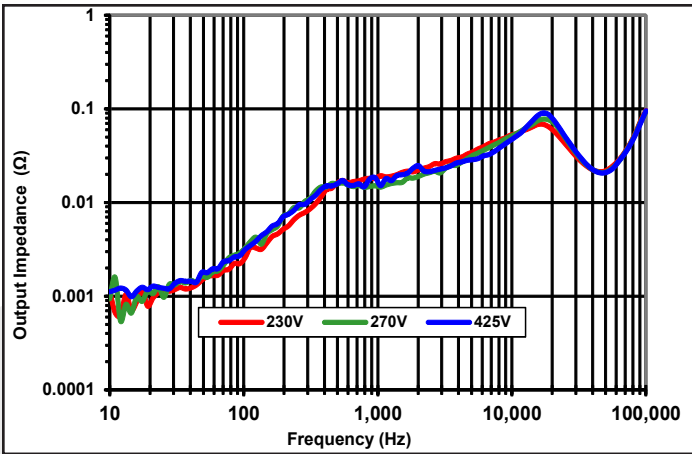

Figure 13: Magnitude of incremental output impedance ($Z_{out} = v_{out}/i_{out}$) for minimum, nominal, and maximum input voltage at full rated power.

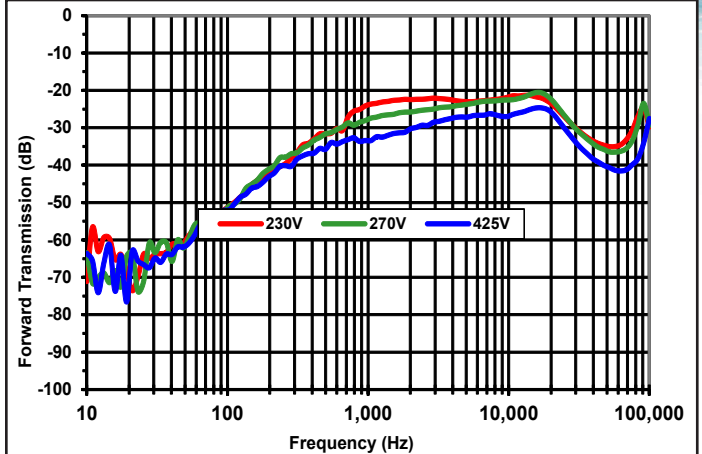

Figure 14: Magnitude of incremental forward transmission ($FT = v_{out}/v_{in}$) for minimum, nominal, and maximum input voltage at full rated power.

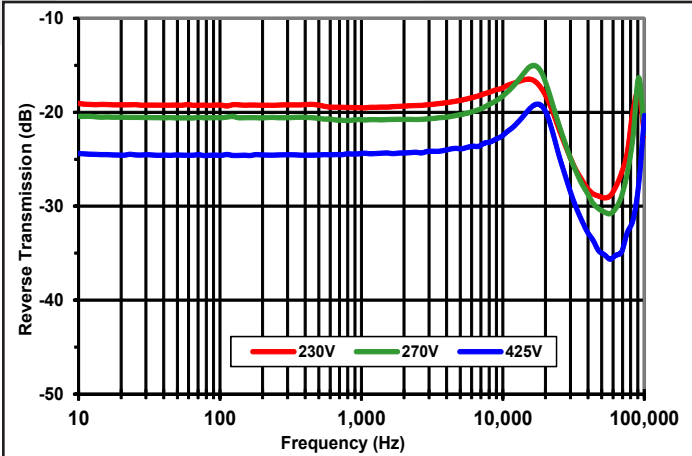

Figure 15: Magnitude of incremental reverse transmission ($RT = i_{in}/i_{out}$) for minimum, nominal, and maximum input voltage at full rated power.

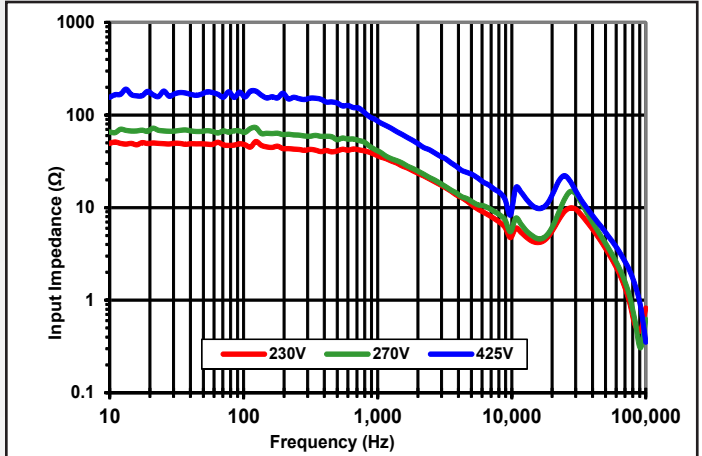

Figure 16: Magnitude of incremental input impedance ($Z_{in} = v_{in}/i_{in}$) for minimum, nominal, and maximum input voltage at full rated power.

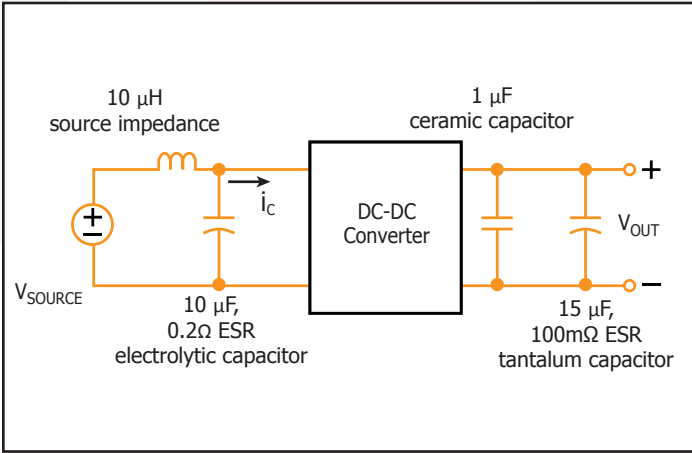

Figure 17: Test set-up diagram showing measurement points for Input Terminal Ripple Current (Figure 9) and Output Voltage Ripple (Figure 10).

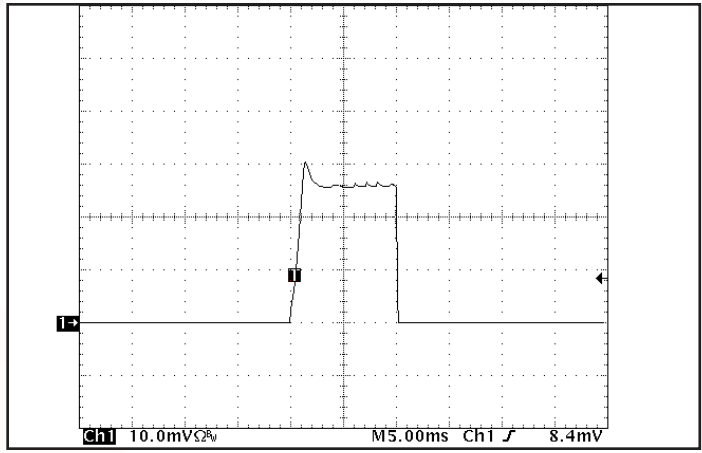

Figure 18: Load current (20A/div) as a function of time (5ms/div) when the converter attempts to turn on into a 10 m Ω short circuit.



MCOTS-C-270-12-HP

Output: 12V

Current: 42A

Application Section

BASIC OPERATION AND FEATURES

This Mil-COTS converter series uses a two-stage power conversion topology. The first stage is a buck-converter that keeps the output voltage constant over variations in line, load, and temperature. The second stage uses a transformer to provide the functions of input/output isolation and voltage step-down to achieve the output voltage required.

Both the first stage and the second stage switch at a fixed frequency for predictable EMI performance. Rectification of the transformer's output is accomplished with synchronous rectifiers. These devices, which are MOSFETs with a very low on-state resistance, dissipate far less energy than Schottky diodes. This is the primary reason that the converter has such high efficiency, even at very low output voltages and very high output currents.

These converters are offered totally encased to withstand harsh environments and thermally demanding applications. Dissipation throughout the converter is so low that it does not require a heatsink for operation in many applications; however, adding a heatsink provides improved thermal derating performance in extreme situations.

This series of converters uses the industry standard footprint and pin-out configuration.

CONTROL FEATURES

REMOTE ON/OFF (Pin 2): The ON/OFF input, Pin 2, permits the user to control when the converter is on or off. This input is referenced to the return terminal of the input bus, IN RTN. The ON/OFF signal is active low (meaning that a low turns the converter on). Figure A details four possible circuits for driving the ON/OFF pin. Figure B is a detailed look of the internal ON/OFF circuitry.

REMOTE SENSE(+) (Pins 7 and 5): The +SNS inputs correct for voltage drops along the conductors that connect the converter's output pins to the load. Pin 7 should be connected to +VOUT and Pin 5 should be connected to OUT RTN at the point on the board where regulation is desired. A remote connection at the load can adjust for a voltage drop only as large as that specified in this datasheet, that is

$$[+VOUT - OUT RTN] - [+SNS - (-SNS)] \leq \text{Sense Range \%} \times V_{out}$$

Pins 7 and 5 must be connected for proper regulation of the output voltage. If these connections are not made, the converter will deliver an output voltage that is slightly higher than its specified value. Note: the output over-voltage protection circuit senses the voltage across the output (pins 8 and 4) to determine when it should trigger, not the voltage across the converter's sense leads (pins 7 and 5). Therefore, the resistive drop on the board should be small enough so that output OVP does not trigger, even during load transients.

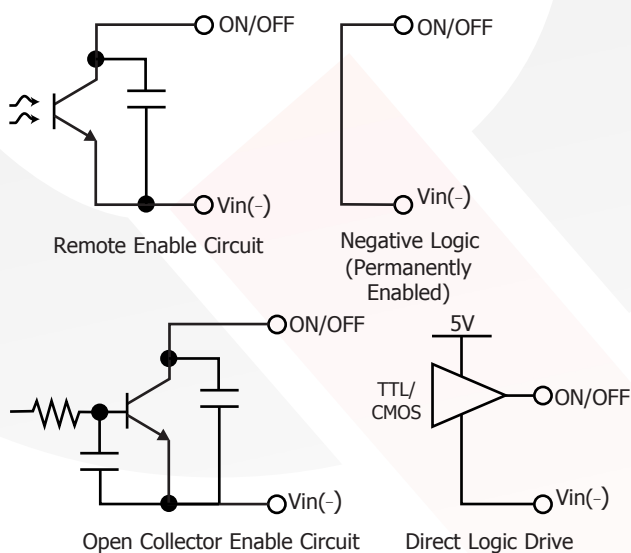

Figure A: Various circuits for driving the ON/OFF pin.

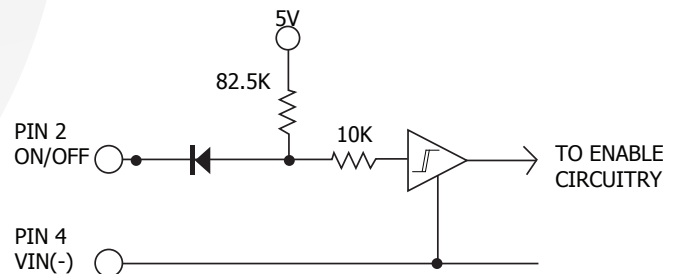

Figure B: Internal ON/OFF pin circuitry

OUTPUT VOLTAGE TRIM (Pin 6): The TRIM input permits the user to adjust the output voltage across the sense leads up or down according to the trim range specifications.

To decrease the output voltage, the user should connect a resistor between Pin 6 (TRIM) and Pin 5 (-SNS input). For a desired decrease of the nominal output voltage, the value of the resistor should be:



MCOTS-C-270-12-HP

Output: 12V

Current: 42A

Application Section

$$R_{\text{trim-down}} = \left(\frac{90.9}{\Delta\%} \right) - 0.909 \text{ (k}\Omega\text{)}$$

where

$$\Delta\% = \left| \frac{V_{\text{nominal}} - V_{\text{desired}}}{V_{\text{nominal}}} \right| \times 100\%$$

To increase the output voltage, the user should connect a resistor between Pin 6 (TRIM) and Pin 7 (+SNS input). For a desired increase of the nominal output voltage, the value of the resistor should be:

$$R_{\text{trim-up}} = \left(\frac{1.0V_{\text{OUT}} \times (100 + \Delta\%)}{1.225\Delta\%} - \frac{90.9}{\Delta\%} - 0.909 \right) \text{ (k}\Omega\text{)}$$

where

Vout = Nominal Output Voltage

Trim graphs show the relationship between the trim resistor value and Rtrim-up and Rtrim-down, showing the total range the output voltage can be trimmed up or down.

Note: the TRIM feature does not affect the voltage at which the output over-voltage protection circuit is triggered. Trimming the output voltage too high may cause the over-voltage protection circuit to engage, particularly during transients.

It is not necessary for the user to add capacitance at the Trim pin. The node is internally bypassed to eliminate noise.

Total DC Variation of VOUT: For the converter to meet its full specifications, the maximum variation of the dc value of VOUT, due to both trimming and remote load voltage drops, should not be greater than that specified for the output voltage trim range.

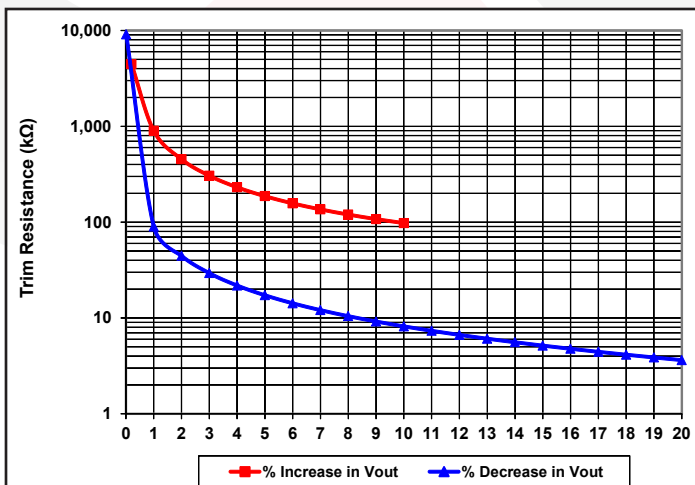

Figure C: Trim graph for trim-up, trim down.

Protection Features

Input Under-Voltage Lockout: The converter is designed to turn off when the input voltage is too low, helping avoid an input system instability problem, described in more detail in the application note titled "Input System Instability" available on www.SynQor.com. The lockout circuitry is a comparator with DC hysteresis. When the input voltage is rising, it must exceed the typical Turn-On Voltage Threshold value (listed on the specification page) before the converter will turn on. Once the converter is on, the input voltage must fall below the typical Turn-Off Voltage Threshold value before the converter will turn off.

Output Over-Voltage Limit: If the voltage across the output pins exceeds the Output Over-Voltage Protection threshold, the converter will immediately stop switching. This prevents damage to the load circuit due to 1) excessive series resistance in output current path from converter output pins to sense point, 2) a release of a short-circuit condition, or 3) a release of a current limit condition. Load capacitance determines exactly how high the output voltage will rise in response to these conditions. After 250 ms the converter will automatically restart.

Over-Temperature Shutdown: A temperature sensor on the converter senses the average temperature of the module. The thermal shutdown circuit is designed to turn the converter off when the temperature at the sensed location reaches the Over-Temperature Shutdown value. It will allow the converter to turn on again when the temperature of the sensed location falls by the amount of the Over-Temperature Shutdown Restart Hysteresis value.

Output Current Limit: The maximum current limit remains constant as the output voltage drops. However, once the impedance of the load across the output is small enough to make the output voltage drop below the specified Output DC Current-Limit Shutdown Voltage, the converter turns off.

The converter then enters a "hiccup" mode where it repeatedly turns on and off at a 4 Hz (nominal) frequency with 11% duty cycle until the short circuit condition is removed. This prevents excessive heating of the converter or the load board.



MCOTS-C-270-12-HP

Output: 12V

Current: 42A

Application Section

APPLICATION CONSIDERATIONS

Input System Instability: This condition can occur because any dc-dc converter appears incrementally as a negative resistance load. A detailed application note titled "Input System Instability" is available on the SynQor website which provides an understanding of why this instability arises, and shows the preferred solution for correcting it.

Application Circuits: Figure D provides a typical circuit diagram which details the input filtering and voltage trimming.

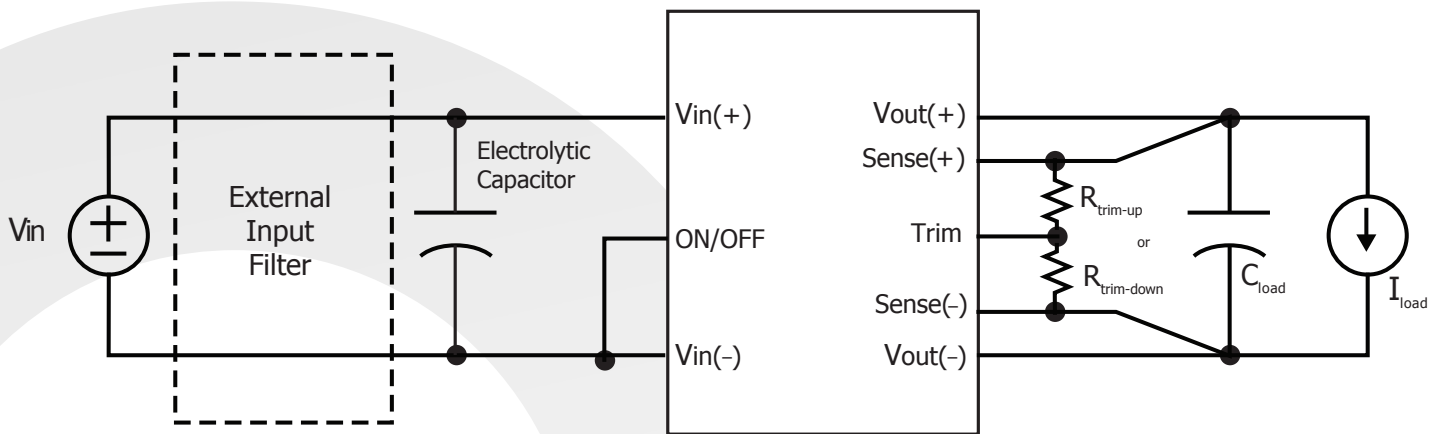

Figure D: Typical application circuit (negative logic unit, permanently enabled).

Input Filtering and External Capacitance: Figure E provides a diagram showing the internal input filter components. This filter dramatically reduces input terminal ripple current, which otherwise could exceed the rating of the converter's external electrolytic input capacitor. The recommended external input capacitance is specified in the Input Characteristics section on the Electrical Characteristics page. More detailed information is available in the application note titled "EMI Characteristics" on the SynQor website.

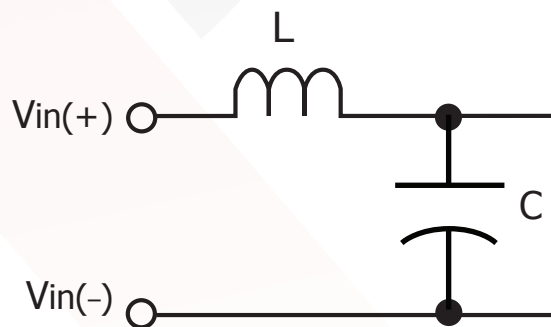

Figure E: Internal Input Filter Diagram (Component values listed on page 3)



MCOTS-C-270-12-HP

Output: 12V

Current: 42A

Application Section

Startup Inhibit Period: The Startup Inhibit Period ensures that the converter will remain off for approximately 250 ms when it is shut down for any reason. When an output short is present, this generates a 4 Hz "hiccup" mode, which prevents the converter from overheating. In all, there are seven ways that the converter can be shut down, initiating a Startup Inhibit Period:

- Input Under-Voltage Lockout
- Input Over-Voltage Lockout
- Output Over-Voltage Protection
- Over Temperature Shutdown
- Current Limit
- Short Circuit Protection
- Turned off by the ON/OFF input

Figure F shows three turn-on scenarios, where a Startup Inhibit Period is initiated at t_0 , t_1 , and t_2 :

Before time t_0 , when the input voltage is below the UVL threshold, the unit is disabled by the Input Under-Voltage Lockout feature. When the input voltage rises above the UVL threshold, the Input Under-Voltage lockout is released, and a Startup Inhibit Period is initiated. At the end of this delay, the ON/OFF pin is evaluated, and since it is active, the unit turns on.

At time t_1 , the unit is disabled by the ON/OFF pin, and it cannot be enabled again until the Startup Inhibit Period has elapsed.

When the ON/OFF pin goes high after t_2 , the Startup Inhibit Period has elapsed, and the output turns on within the typical Turn-On Time.

Thermal Considerations: The maximum operating base-plate temperature, T_B , is 100 °C. Refer to the thermal derating curve, Figure 5, to see the available output current at baseplate temperatures below 100 °C.

A power derating curve can be calculated for any heatsink that is attached to the base-plate of the converter. It is only necessary to determine the thermal resistance, $R_{TH_{BA}}$, of the chosen heatsink between the base-plate and the ambient air for a given airflow rate. This information is usually available from the heatsink vendor. The following formula can then be used to determine the maximum power the converter can dissipate for a given thermal condition:

$$P_{diss}^{max} = \frac{T_B - T_a}{R_{TH_{BA}}}$$

This value of power dissipation can then be used in conjunction with the data shown in Figure 3 to determine the maximum load current (and power) that the converter can deliver in the given thermal condition.

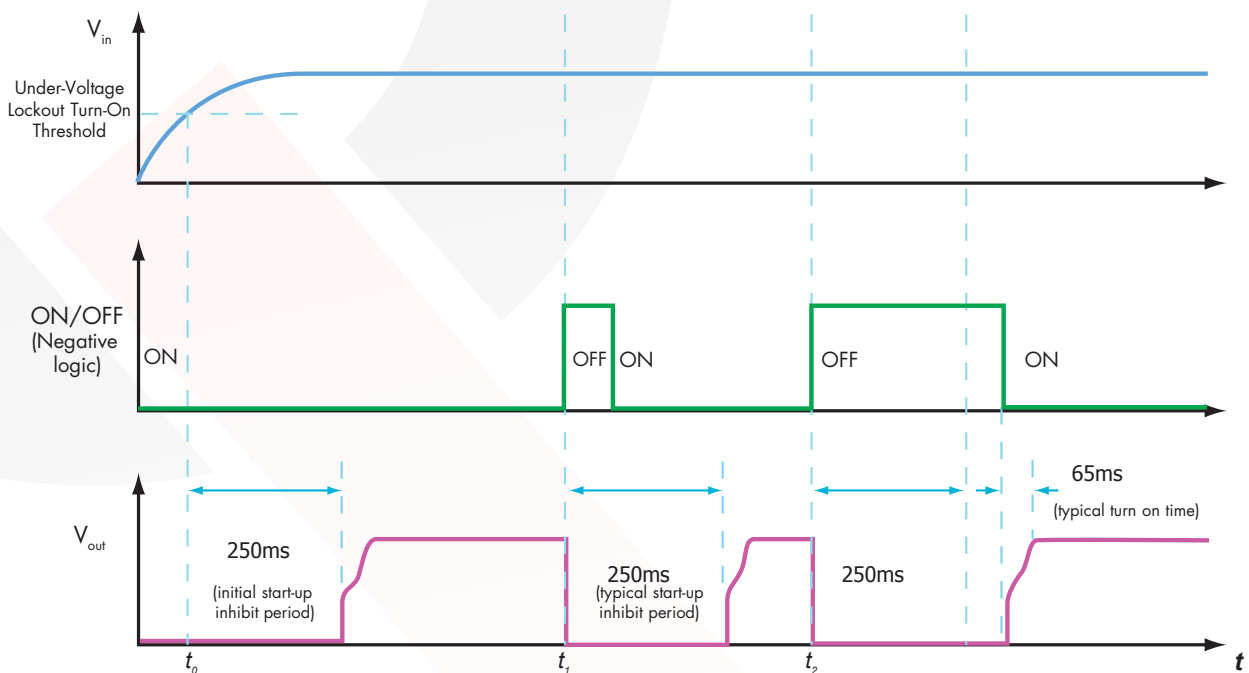

Figure F: Startup Inhibit Period (turn-on time not to scale)



MCOTS-C-270-12-HP

Output: 12V

Current: 42A

Application Section

Full-Featured Application Notes

This section provides some basic application information for the full-feature version of the MCOTS series converter.

All units in this product family include back-drive protection to simplify the use of multiple converters in a parallel or sequencing application. However, any voltage applied to the output of the converter should be kept below 120% of the rated output voltage of the converter.

In addition to back-drive protection, these units include the following features (pins):

SHARE (pin C): The active current share feature allows for N+1 and parallel applications. To achieve load sharing, directly connect the SHARE pins of multiple units. The load current will share equally among the multiple units ($\pm 5\%$ at full rated current). It is important that the IN RTN pins of the sharing units be directly connected and NOT placed outside of an EMI filter or other impedance path. The voltage at the SHARE pin will range from 1.0 to 2.2 volts (at full rated current), referenced to the primary-side ground, IN RTN.

START SYNC (pin B): The Start Synchronization pin will allow a more consistent start-up sequence. To operate this feature, connect together the Start-Sync pins of multiple current-sharing units. This will permit immediate start-up with loads greater than the current limit of a single unit. Without this connection, any set of converters attempting to asynchronously start (or re-start) with a load greater than the current limit of a single unit will "hiccup". This "hiccup" mode will continue until one converter attempts a start at the same time as the minimum number of additional units necessary to sustain the load condition. For example, three 50 amp units starting into a 90 amp load would require two units to simultaneously attempt a start. The Start Sync connection synchronizes these starting attempts and provides a more consistent and reliable start-up sequence. For details about the "hiccup" mode or repeated startup attempts, please see the "Startup Inhibit Period" note in the Technical Specification.

CLOCK SYNC (pin A): The External Clock Synchronization pin provides the ability for the user to control the EMI signature and synchronize sensitive circuitry to quiet periods in the converter operation. With this option, the converter can be synchronized to an external clock signal whose frequency is greater than that of the free-running internal clock. However, substantially raising the converter's frequency will reduce its efficiency. Therefore, the recommended frequency range for the external clock synchronization signal applied to this pin is listed in the Technical Specification.

The following requirements should also be met:

- The external clock signal should be referenced to the negative input voltage, IN RTN.
- The high level of the signal should be between 1.6V and 3.3V.
- The low level should be between -0.5V and +0.8V.
- For using more than 5 units in parallel Contact SynQor.



MCOTS-C-270-12-HP

Output: 12V

Current: 42A

Standard Mechanical Drawing

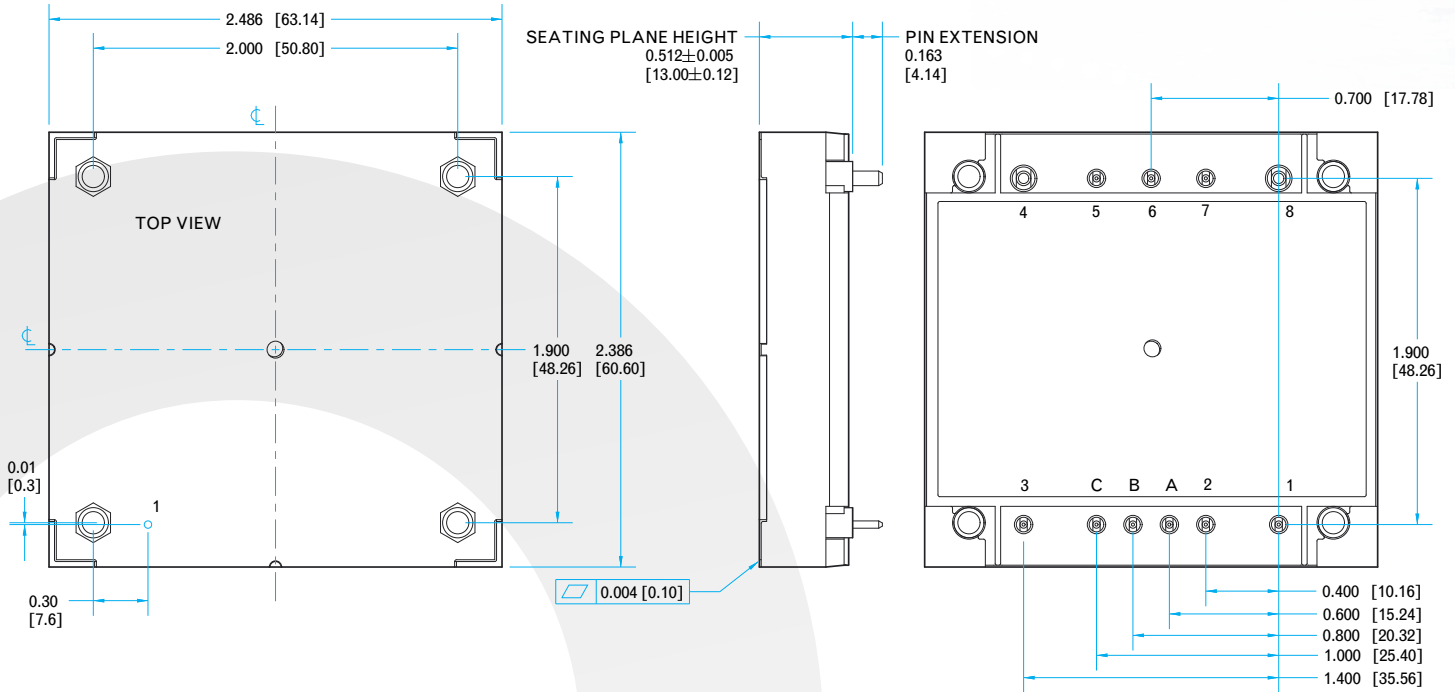

NOTES

- 1) APPLIED TORQUE PER M3 SCREW SHOULD NOT EXCEED 6in-lb (0.7 Nm)
SCREW SHOULD NOT EXCEED 0.100" (2.54mm) DEPTH BELOW THE SURFACE OF THE BASEPLATE.
- 2) BASEPLATE FLATNESS TOLERANCE IS 0.004" (.10mm) TIR FOR SURFACE.
- 3) PINS 1-3, 5-7, A, B, AND C ARE 0.040" (1.02mm) DIA. WITH 0.080" (2.03mm) DIA. STANDOFFS.
- 4) PINS 4 AND 8 ARE 0.080" (2.03mm) DIA. WITH 0.125" (3.18mm) DIA STANDOFFS
- 5) ALL PINS: MATERIAL: COPPER ALLOY
FINISH: MATTE TIN OVER NICKEL PLATE
- 6) WEIGHT: 5.0 oz. (142 g) TYPICAL
- 7) ALL DIMENSIONS IN INCHES(mm)
- 8) TOLERANCES: X.XXIN +/-0.02 (X.Xmm +/-0.5mm)
X.XXXIN +/-0.010 (X.XXmm +/-0.25mm)

PIN DESIGNATIONS

Pin	Name	Function
1	Vin(+)	Positive input voltage
2	ON/OFF	TTL input to turn converter on and off, referenced to Vin(-), with internal pull up.
A	CLOCK SYNC	Clock synchronization
B	START SYNC	Startup synchronization
C	I SHARE	Single wire parallel signal
3	IN RTN	Input Return
4	OUT RTN	Output Return
5	SENSE(-)	Negative remote sense ¹
6	TRIM	Output voltage trim ²
7	SENSE(+)	Positive remote sense ³
8	Vout(+)	Positive output voltage

Notes:

- 1) SENSE(-) should be connected to Vout(-) either remotely or at the converter.
- 2) Leave TRIM pin open for nominal output voltage.
- 3) SENSE(+) should be connected to Vout(+) either remotely or at the converter.
- 4) Pins A, B, and C are populated on Full Feature version only.



SynQor®

Flanged Mechanical Drawing

MCOTS-C-270-12-HP
Output: 12V
Current: 42A

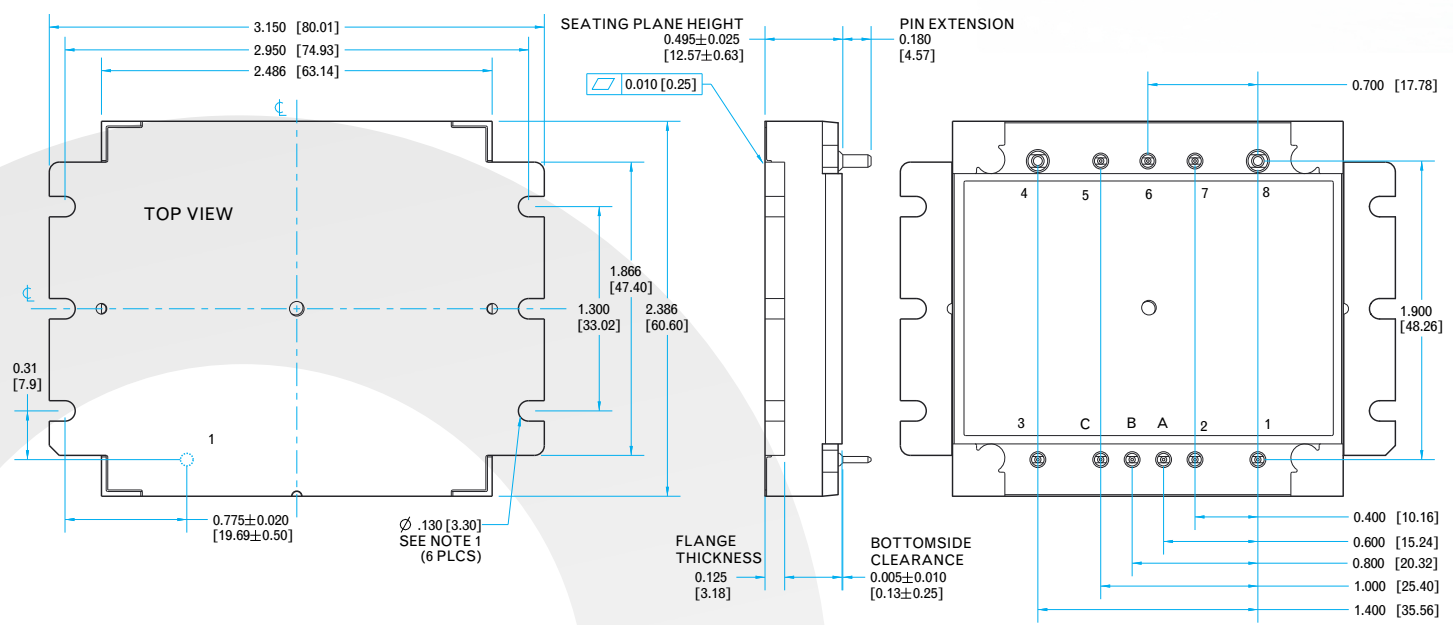

NOTES

- 1) APPLIED TORQUE PER M3 OR 4-40 SCREW SHOULD NOT EXCEED 6 in-lb (0.7 Nm)
- 2) BASEPLATE FLATNESS TOLERANCE IS 0.010" (.25mm) TIR FOR SURFACE.
- 3) PINS 1-3, 5-7, A, B, AND C ARE 0.040" (1.02mm) DIA. WITH 0.080" (2.03mm) DIA. STANDOFFS.
- 4) PINS 4 AND 8 ARE 0.080" (2.03mm) DIA. WITH 0.125" (3.18mm) DIA STANDOFFS
- 5) ALL PINS: MATERIAL: COPPER ALLOY
FINISH: MATTE TIN OVER NICKEL PLATE
- 6) WEIGHT: 5.2 oz. (148 g) TYPICAL
- 7) ALL DIMENSIONS IN INCHES(mm)
- 8) TOLERANCES: X.XXIN +/-0.02 (X.Xmm +/-0.5mm)
X.XXXIN +/-0.010 (X.XXmm +/-0.25mm)

PIN DESIGNATIONS

Pin	Name	Function
1	Vin(+)	Positive input voltage
2	ON/OFF	TTL input to turn converter on and off, referenced to Vin(-), with internal pull up.
A	CLOCK SYNC	Clock synchronization
B	START SYNC	Startup synchronization
C	I SHARE	Single wire parallel signal
3	IN RTN	Input Return
4	OUT RTN	Output Return
5	SENSE(-)	Negative remote sense ¹
6	TRIM	Output voltage trim ²
7	SENSE(+)	Positive remote sense ³
8	Vout(+)	Positive output voltage

Notes:

- 1) SENSE(-) should be connected to Vout(-) either remotely or at the converter.
- 2) Leave TRIM pin open for nominal output voltage.
- 3) SENSE(+) should be connected to Vout(+) either remotely or at the converter.
- 4) Pins A, B, and C are populated on Full Feature version only.



SynQor®

Qualifications & Screening

MCOTS-C-270-12-HP

Output: 12V

Current: 42A

Mil-COTS Qualification

Test Name	Details	# Tested (# Failed)	Consistent with MIL-STD-883F Method
Life Testing	Visual, mechanical and electrical testing before, during and after 1000 hour burn-in @ full load	15 (0)	Method 1005.8
Shock-Vibration	Visual, mechanical and electrical testing before, during and after shock and vibration tests	5 (0)	MIL-STD-202, Methods 201A & 213B
Humidity	+85 °C, 95% RH, 1000 hours, 2 minutes on / 6 hours off	8 (0)	Method 1004.7
Temperature Cycling	500 cycles of -55 °C to +100 °C (30 minute dwell at each temperature)	10 (0)	Method 1010.8, Condition A
Solderability	15 pins	15 (0)	Method 2003
DMT	-65 °C to +110 °C across full line and load specifications in 5 °C steps	7 (0)	
Altitude	70,000 feet (21 km), see Note	2 (0)	

Note: A conductive cooling design is generally needed for high altitude applications because of naturally poor convective cooling at rare atmospheres.

Mil-COTS Converter and Filter Screening

Screening	Process Description	S-Grade	M-Grade
Baseplate Operating Temperature		-55 °C to +100 °C	-55 °C to +100 °C
Storage Temperature		-65 °C to +135 °C	-65 °C to +135 °C
Pre-Cap Inspection	IPC-A-610, Class III	•	•
Temperature Cycling	MIL-STD-883F, Method 1010, Condition B, 10 Cycles		•
Burn-In	100 °C Baseplate	12 Hours	96 Hours
Final Electrical Test	100%	25 °C	-55 °C, +25 °C, +100 °C
Final Visual Inspection	MIL-STD-883F, Method 2009	•	•

Mil-COTS MIL-STD-810G Qualification Testing

MIL-STD-810G Test	Method	Description
Fungus	508.6	Table 508.6-I
Altitude	500.5 - Procedure I	Storage: 70,000 ft / 2 hr duration
	500.5 - Procedure II	Operating: 70,000 ft / 2 hr duration; Ambient Temperature
Rapid Decompression	500.5 - Procedure III	Storage: 8,000 ft to 40,000 ft
Acceleration	513.6 - Procedure II	Operating: 15 g
Salt Fog	509.5	Storage
High Temperature	501.5 - Procedure I	Storage: 135 °C / 3 hrs
	501.5 - Procedure II	Operating: 100 °C / 3 hrs
Low Temperature	502.5 - Procedure I	Storage: -65 °C / 4 hrs
	502.5 - Procedure II	Operating: -55 °C / 3 hrs
Temperature Shock	503.5 - Procedure I - C	Storage: -65 °C to 135 °C; 12 cycles
Rain	506.5 - Procedure I	Wind Blown Rain
Immersion	512.5 - Procedure I	Non-Operating
Humidity	507.5 - Procedure II	Aggravated cycle @ 95% RH (Figure 507.5-7 aggravated temp - humidity cycle, 15 cycles)
Random Vibration	514.6 - Procedure I	10 - 2000 Hz, PSD level of 1.5 g ² /Hz (54.6 g _{rms}), duration = 1 hr/axis
Shock	516.6 - Procedure I	20 g peak, 11 ms, Functional Shock (Operating no load) (saw tooth)
	516.6 - Procedure VI	Bench Handling Shock
Sinusoidal vibration	514.6 - Category 14	Rotary wing aircraft - helicopter, 4 hrs/axis, 20 g (sine sweep from 10 - 500 Hz)
Sand and Dust	510.5 - Procedure I	Blowing Dust
	510.5 - Procedure II	Blowing Sand



MCOTS-C-270-12-HP

Output: 12V

Current: 42A

Ordering Information

Ordering Information/ Part Numbering

Example MCOTS-C-270-12-HP-N-S

Not all combinations make valid part numbers, please contact SynQor for availability.

Family	Product	Input Voltage	Output Voltage	Package	Thermal Design	Screening Level	Options
MCOTS	C: Converter	270: 230-425V	05: 5V 12: 12V 28: 28V 48: 48V	HP: Half Brick Peta	N: Normal Threaded D: Non-Threaded F: Flanged	S: S-Grade M: M-Grade	[]: Standard Feature F: Full Feature

APPLICATION NOTES

A variety of application notes and technical white papers can be downloaded in PDF format from our [website](#).

Contact SynQor for further information and to order:

Phone: 978-849-0600 Toll Free: 888-567-9596 Fax: 978-849-0602

E-mail: power@synqor.com Web: www.synqor.com

Address: 155 Swanson Road, Boxborough, MA 01719 USA

WARRANTY

SynQor offers a two (2) year limited warranty. Complete warranty information is listed on our website or is available upon request from SynQor.

PATENTS

SynQor holds numerous U.S. patents, one or more of which apply to most of its power conversion products. Any that apply to the product(s) listed in this document are identified by markings on the product(s) or on internal components of the product(s) in accordance with U.S. patent laws. SynQor's patents include the following:

7,050,309 7,765,687 7,787,261
8,149,597 8,644,027